

Surface-mounted profile BLine Select HT02

BLine Select HT02 LED surface-mounted profile alu silver 35W/m W29xH24xL6000mm

Article no.: 170689

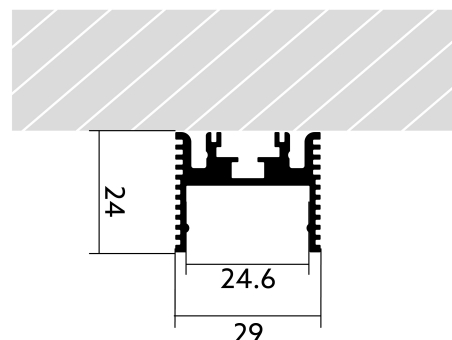
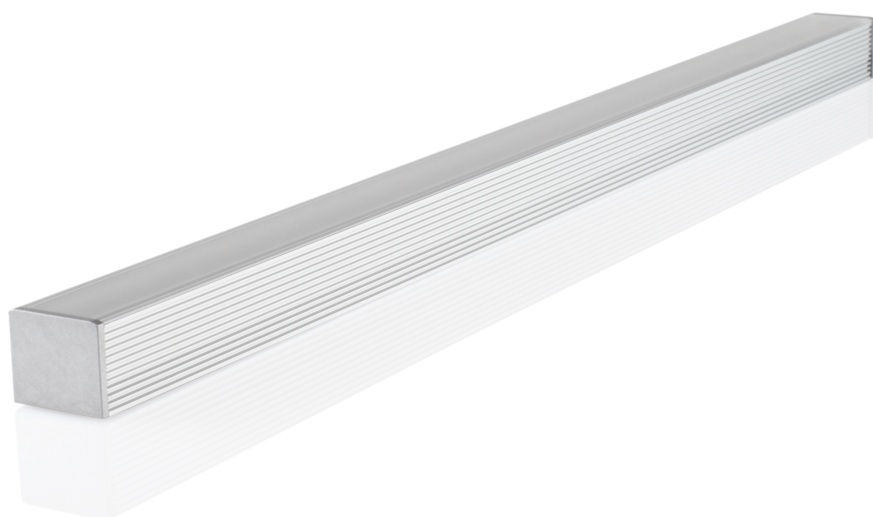

Material



Power consumption



Height



Width

TENDER TEXT

Profile HT, surface-mounted aluminium, 35W/m, L 6000 x W 29 x H 24 mm BILTON LEDON Technology Surface-mounted profile BLine Select HT02 Article 170689 The Surface-mounted profile BLine Select HT02 can be combined with all covers from the HT family. The profile is made of Aluminium with an finish and has a power consumption of up to 35 W. Dimensions (L x W x H): 6000.0 mm x 29.0 mm x 24.0 mm Please note that cutting tolerances of +/- 2mm may occur.

Surface-mounted profile BLine Select HT02

BLine Select HT02 LED surface-mounted profile alu silver 35W/m W29xH24xL6000mm

Article no.: 170689



MECHANICAL DATA

Material	Aluminium
Width [mm]	29.0
Length [mm]	6000.0
Height [mm]	24.0
Mounting method	Aufbau
Colour	lichtgrau
Power consumption [W]	35
Material quality	sonstige
Surfacetreatment	anodisiert / eloxiert

TEMPERATURE TECHNICAL DATA

Power consumption [W]	35
Thermal conductivity	23.4

PACKAGING INFORMATION

EAN	4251160704666
Article no.	170689
Net weight [g]	3468
Gross weight [g]	3468
Gross width [mm]	29.0
Gross height [mm]	24.0
Gross length [mm]	3000.0
Customs tariff number	94054239
Net width [mm]	29.0
Net height [mm]	24
Net length [mm]	3000
State of origin	DE

NECESSARY ACCESSORIES

Article	Article no.
Angle steel XTC4	170456
Clip steel YTC5	170468
Angle ALU YTC8	170469
Nut Connector YTV1	170471
Endcap HT002	170632

SAFETY INFORMATION: Read the safety and installation instructions carefully and completely before commissioning. The operating instructions can be found at: www.better-light.at

Surface-mounted profile BLine Select HT02

BLine Select HT02 LED surface-mounted profile alu silver 35W/m W29xH24xL6000mm

Article no.: 170689



DISCLAIMER OF WARRANTY: The technical information corresponds to the status at the time of printing and have been worked out to the best of our knowledge. However, errors and printing errors are reserved. Make sure that you always use the latest version of the data sheets. The latest data sheet can be found at: www.better-light.at